

Web Page Settings Guide

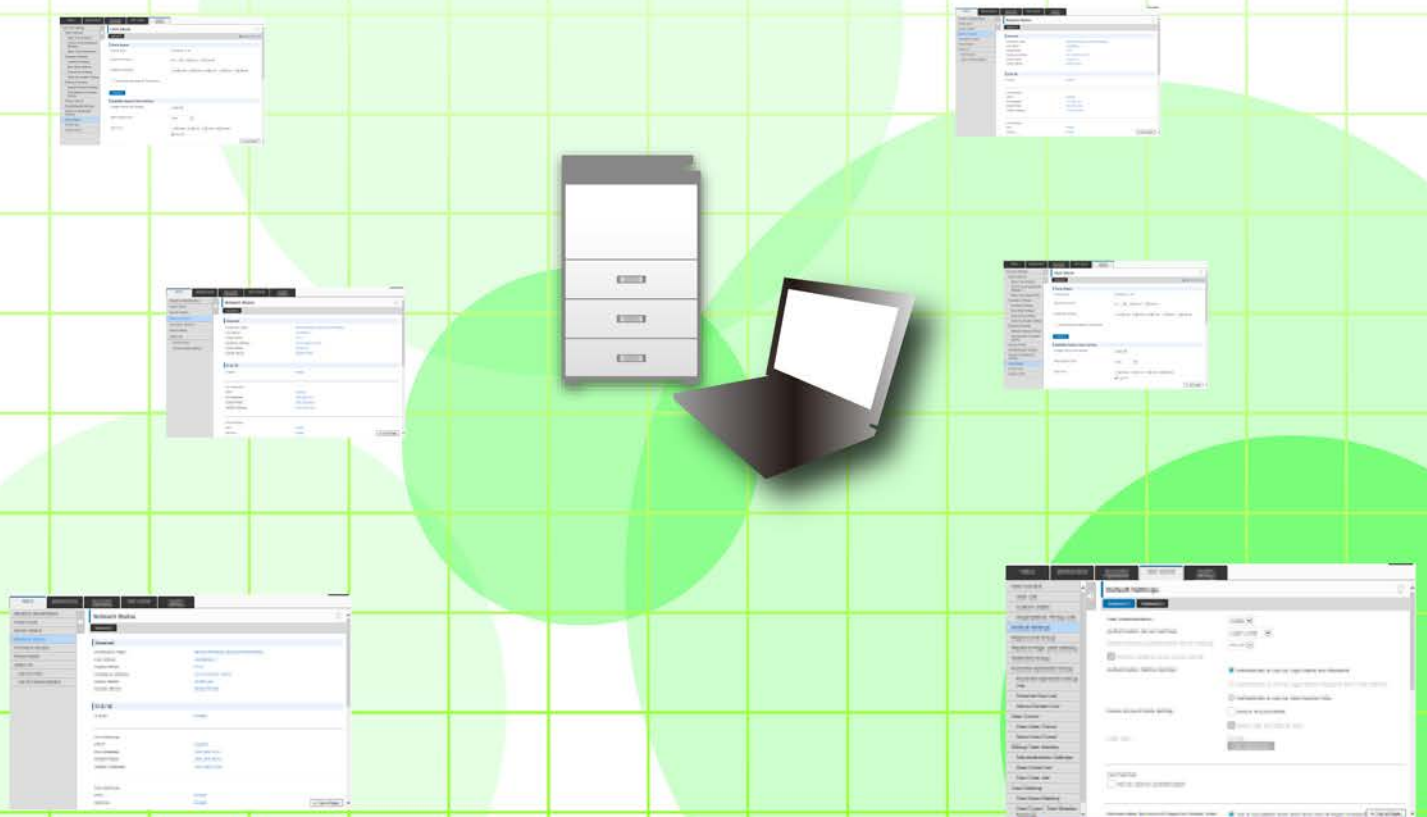

TABLE OF CONTENTS

ABOUT THIS GUIDE	2
WEB PAGE	3
• Web page features	3
• Accessing the web page	3
WEB PAGE SETTINGS	5
• Overview of web page	5
• Menu tab	6
• How to configure web page settings	7
• Energy Save	10
• Security Settings	11
• Category Setting	14
• Document Operations	16
• User Control	17
• System Settings	27
CUSTOMIZING THE WEB PAGE	31
• Custom Link Setting	31
• Shortcuts	32
WEB PAGE SETTING LIST	33

ABOUT THIS GUIDE

This guide explains the procedures for configuring machine settings from your computer using the web page settings function embedded in the machine.

Please note

- This guide assumes that the persons who install and use this product have a working knowledge of their computer and web browser.
- For information on your operating system or web browser, please refer to your operating system guide or web browser guide, or the online Help function.
- The explanations of screens and procedures are primarily for Internet Explorer® on Windows® 8.1. The screens may vary depending on the version of the operating system or the software application.
- Wherever "MX-xxxx" appears in this guide, please substitute your model name for "xxxx".
- Considerable care has been taken in preparing this manual. If you have any comments or concerns about the manual, please contact your dealer or nearest authorized service representative.
- This product has undergone strict quality control and inspection procedures. In the unlikely event that a defect or other problem is discovered, please contact your dealer or nearest authorized service representative.
- Aside from instances provided for by law, SHARP is not responsible for failures occurring during the use of the product or its options, or failures due to incorrect operation of the product and its options, or other failures, or for any damage that occurs due to use of the product.

Warning

- Reproduction, adaptation or translation of the contents of the manual without prior written permission is prohibited, except as allowed under copyright laws.
- All information in this manual is subject to change without notice.

Illustrations, operation panel, touch panel, and Web pages in this guide

The peripheral devices are generally optional, however, some models include certain peripheral devices as standard equipment. For some functions and procedures, the explanations assume that devices other than the above are installed. The explanations in this manual are based on American English and the North American version of the software. Software for other countries and regions may vary slightly from the North American version.

- The display screens, messages, and key names shown in the manual may differ from those on the actual machine due to product improvements and modifications.
- The touch panel, illustrations, and setting screens in this manual are for reference only, and may vary by model, installed options, settings changed from the default state, and country or region.
- This manual assumes that a full-color machine is being used. Some of the explanations may not apply to a monochrome machine.

WEB PAGE

Web page features

A web server for settings is embedded in the machine.

When the machine is connected to a network, you can access the web server in the machine to configure a variety of machine settings with your computer.

This function allows you to configure machine settings over the network but not have to walk to the machine.

You can easily enter your user name and other text from your computer.

You can also use the web page to configure settings that are more advanced than those available on the machine.



For detailed information on the settings of the machine, see the User's Manual.

Accessing the web page

This section explains the procedure for accessing the machine's web page.

Supported web browsers

The following web browsers can be used to access the machine:

Internet Explorer: 8 or higher (Windows®)

Firefox (Windows®), Safari (Mac OS®), Chrome (Windows®): Latest version or immediately previous major release

Accessing the web page

Follow the steps below to access the Web page.

1

Open your web browser on your computer.

2

Enter the IP address set in the machine in the address bar of your web browser.

- For the machine's IP address, ask the administrator of the machine.
- You can check the machine's IP address on the machine. "[How to check the IP address of the machine](#)"(▶ page 4)
- **Entering a password**
 - If you click an item that requires administrator rights, the password entry screen will appear regardless of the settings. Select a user that has administrator rights and enter the user password.
 - If user authentication is not enabled, you can set the login name to "Administrator" and enter the administrator password to log in to the Web page.
Once you have logged in to the Web page with administrator rights, the password entry screen will not appear when you click other items that require administrator rights (until you log out).

How to check the IP address of the machine

1 From the settings mode of the machine, open the "List for User" settings page in "Data List" on the "Status" tab.

2 Select the "NIC Page" checkbox and execute "Print".
Check the IP address on the printed list.

WEB PAGE SETTINGS

This chapter explains how to set some of the typical items in the web page settings. For items not explained in this chapter, see the User's Manual.

Overview of web page

When you successfully access the machine's web server, the web page appears in your web browser.

Tabs (1) showing setting items appear at the top of the web page. When you click a tab, the items (2) you can set appear on the left side of the page. When you click the item that you want to set, the setting screen (10) of that item appears on the right side of the page.

When you have completed all settings, click the [Logout] button and exit the web browser.

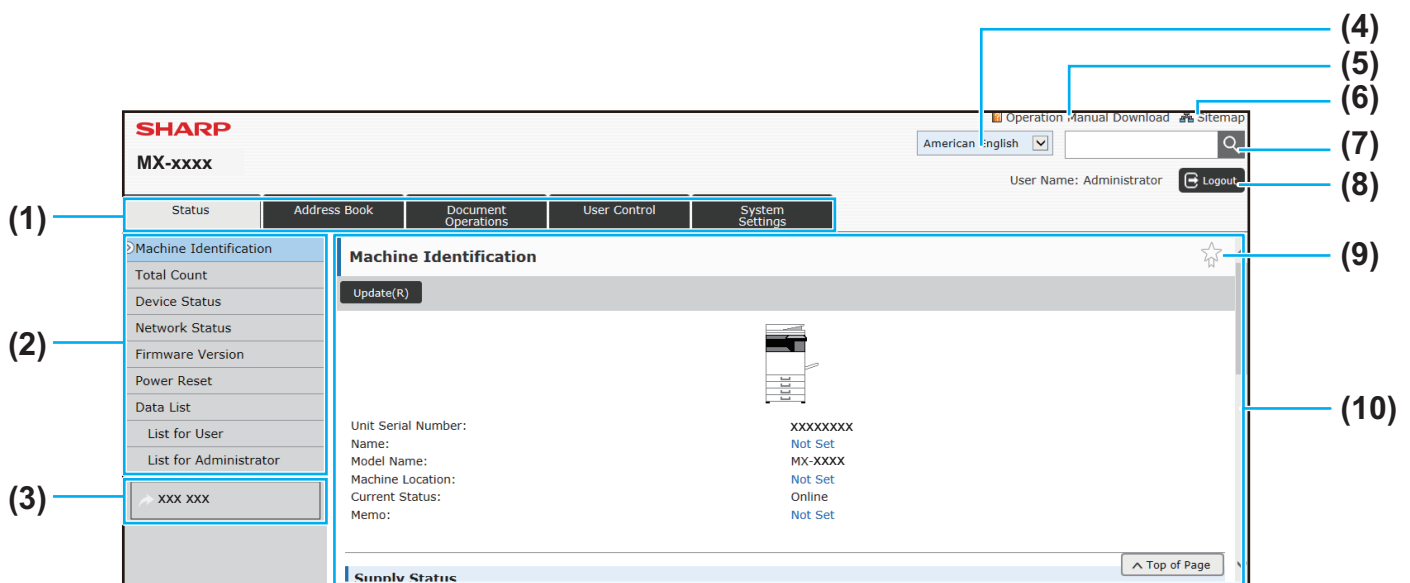

- (1) **Menu tab**
This tab shows the first level of the setting menu. Click this tab to show the tab's setting items in the setting menu.
Some settings such as the system settings do not appear in the setting menu when the tab is clicked. Instead, further setting item buttons appear in the setting area.
▶ [Menu tab \(page 6\)](#)
- (2) **Setting menu**
This shows the items that can be set on the web page. The items are in a tree structure.
When you click an item that requires machine administrator rights, the password entry screen appears. Select the previously registered login name and enter the password.
- (3) **Custom links**
You can register custom links in advance to show the custom links in the setting menu.
▶ [Custom Link Setting \(page 31\)](#)
- (4) **Language**
Set the language that appears on the web page.
- (5) **Operation Manual Download**
This shows the operation manual download page.
- (6) **Sitemap**
This shows a sitemap of the website.
- (7) **Search**
Use this to search for setting items and other information. Enter the item you want to find in the text box and click .
- (8) **[Login/Logout] button**
[Login] button
Click to log in to the web page.
[Logout] button
When you have completed all settings in the web pages, click this button to log out and exit the web browser.
- (9) **Shortcut icon**
Click this icon to register a page you want to show on the shortcut tab.
▶ [Shortcuts \(page 32\)](#)
- (10) **Setting area**
This shows the setting screen of the item selected in the setting menu at left.

Menu tab

Menu	Overview	
Status	Displays paper tray information and device information.	
Address Book	Use to edit the address book.	
Document Operations	Use to perform actions on a file using the Document Filing function.	
User Control	Add, edit, and delete users for user authentication, and configure user authentication settings. You can also select IC card settings.	
System Settings	Configure the main settings for the machine such as date settings and paper tray settings. You can configure the following settings.	
	Home Screen Settings	You can select settings for the machine's home screen, such as changing the home screen background.
	Copy Settings	You can select copy settings.
	Printer Settings	You can select print settings.
	Image Send Settings	Configure settings for image send, such as fax and Scan to E-mail.
	Document Filing Settings	You can select Document Filing settings.
	Sharp OSA Settings	You can select Sharp OSA settings.
	Common Settings	You can configure machine settings such as date settings and tray settings.
	Network Settings	You can configure network settings such as network protocol and NAS settings.
	Security Settings	You can configure machine security settings such as authentication and changing the administrator password.
	Energy Save	The machine's power consumption can be reduced by Eco Mode setting.
	System Control	You can configure machine backup and job log settings.
	Image Quality Adjustment	You can perform image adjustment for printing and scanning on the machine.
Initial Installation Settings	This is a group of settings that are required when you initially install the machine.	

How to configure web page settings

This section explains the basic procedure for configuring web page settings using "Home Screen Settings" as an example. This setting is used to change the background image of a home screen to an image provided by the user.

1

Connect to the web page as explained in "[Accessing the web page](#)" ([page 3](#)).

2

Display the "Home Screen Settings" setting screen.

(1) Click the [System Settings] tab ().

The setting items of the system settings appear in the setting area.

(2) Click the [Home Screen Settings] button ().

(3) Log in to the machine's web page.

When you click the [Home Screen Settings] button in step (2), the login name and password setting screen appears.

Select the login name and enter the password that is set for the login name.

When you have finished, click the [Login] button.

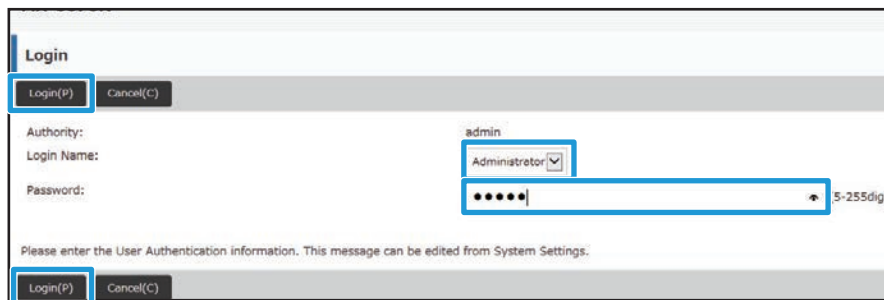

If login is successful, each item of the Home Screen Settings will appear in the setting menu.

3

Click [Background Image] in the setting menu and set the background image.

- (1) Click [Background Image] in the setting menu.
- (2) Click the [Change] button in "Background Image".

The "Home Screen Registration" screen appears.

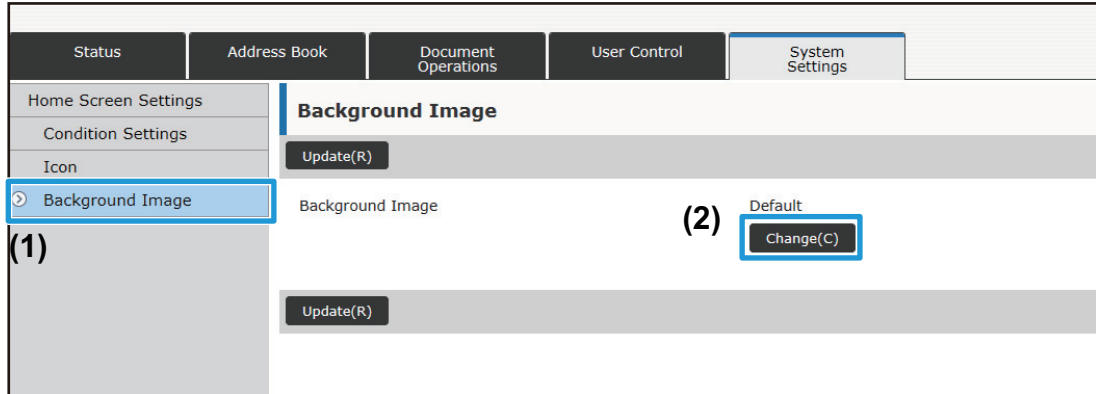

4

Select "Use Custom Image" and click the [Browse] button to select the desired image.

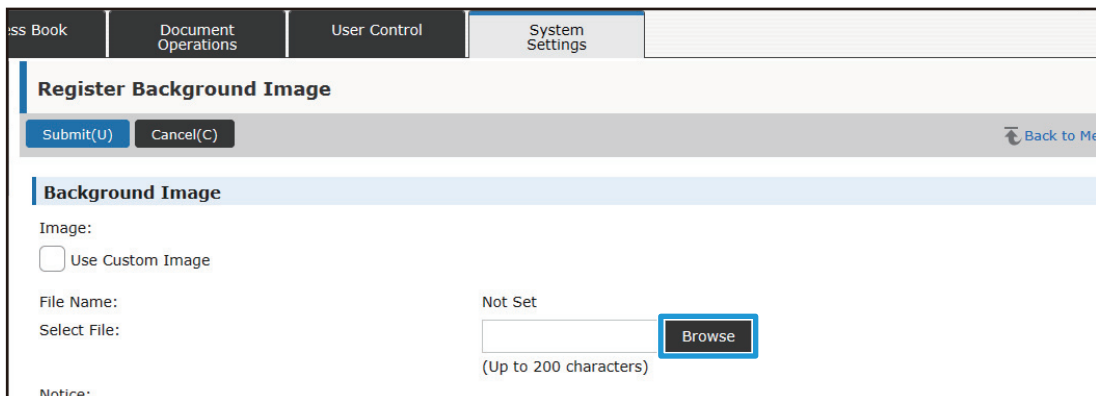

When you click the [Browse] button, the file selection screen appears. Select the file of the desired background image.

5

Make sure the "Select File" path is correct, and click the [Submit] button.

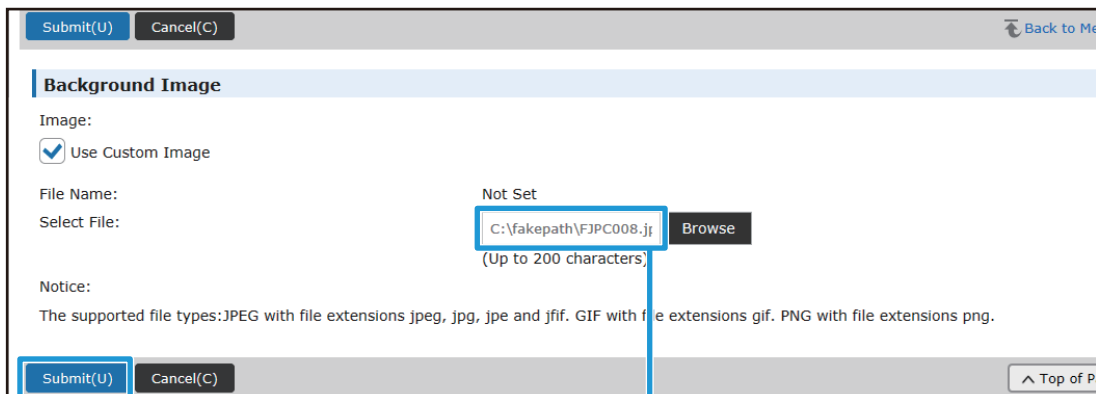

Path

6

If you have another item you want to set, configure the setting from the setting menu or menu tab.



If you use the "Forward" or "Back" function of the web browser to move to a different item, the item that you set may not be saved. Use the setting menu or menu tab to move to a different item.

7

When you have finished configuring settings, click the [Logout] button and exit the web browser.

When you exit the settings, a message may appear on the touch panel of the machine. Read and then close the message.

Energy Save

This section explains how to set the Preheat Mode transmission time and the Auto Power Shut-Off transmission time.

1

Connect to the web page as explained in "[Accessing the web page](#)" ([page 3](#)).

2

Display the "Eco Setting" setting screen.

(1) Click the [System Settings] tab ().

The setting items of the system settings appear in the setting area.

(2) Click the [Energy Save] button ().

The Energy Save items appear in the setting menu.

(3) Click [Eco Setting].

The Eco Setting items appear on the right side.

3

Set the transition time for Preheat Mode and the transition time for Auto Power Shut-Off.

(1) Enter the desired time in the text box in "Preheat Mode Setting".

(2) If you want to set the transition time to the shortest setting with "Auto Power Shut-Off Timer", select [Earliest]. If you want to change the transition time, enter the transition time in the text box.

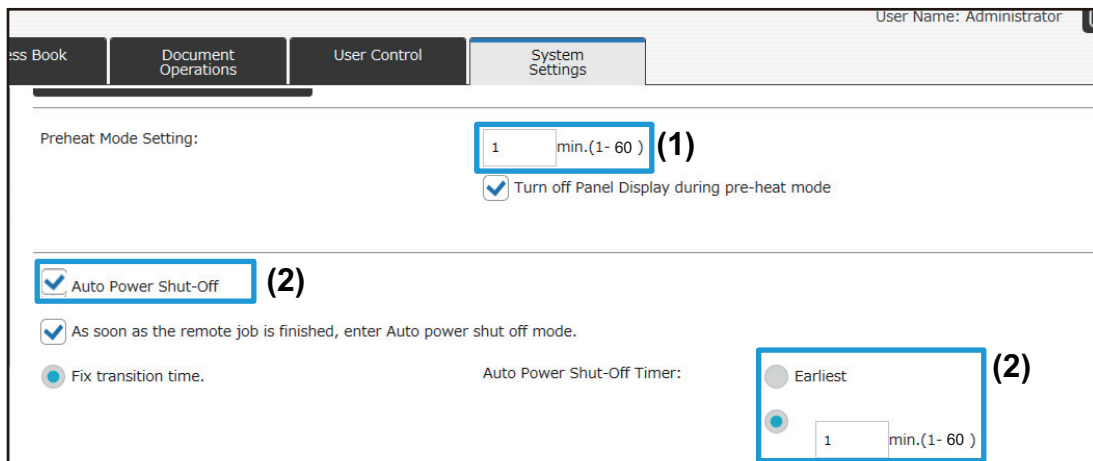

The screenshot shows the "System Settings" tab selected. The "Preheat Mode Setting" section has a text box containing "1" and "min.(1- 60)" next to it, with a circled "1" indicating the input. Below it is a checked checkbox for "Turn off Panel Display during pre-heat mode". The "Auto Power Shut-Off" section has a checked checkbox and a circled "2" next to it. Below that is a checked checkbox for "As soon as the remote job is finished, enter Auto power shut off mode." and a radio button for "Fix transition time." The "Auto Power Shut-Off Timer" section has a radio button for "Earliest" and a text box containing "1" and "min.(1- 60)" next to it, with a circled "2" indicating the input.

4

When you have finished configuring settings, click the [Submit] button, click the [Logout] button, and exit the web browser.

Security Settings

The procedure for changing the administrator password for login and the network security settings used on the machine are explained below.

Changing Administrator Password

If you continue using the administrator password without changing it, the password will become easier to decipher or may be disclosed, creating a risk of unauthorized use of the machine. By periodically changing the administrator password, you can prevent this type of unauthorized access.

1

Connect to the web page as explained in "[Accessing the web page](#)" ([page 3](#)).

2

Display the "Password Change" setting screen.

(1) Click the [System Settings] tab ().

The setting items of the system settings appear in the setting area.

(2) Click the [Security Settings] button ().

The security setting items appear in the setting menu.

(3) Click [Password Change].

The Password Change setting appears on the right.

3

Change the administrator password.

(1) Select the "Change Password" checkbox in "Administrator Password".

(2) Enter the new password you want to set in the "Password" text box.

(3) Reenter the password entered in (2) in the "Password (confirmation)" text box.

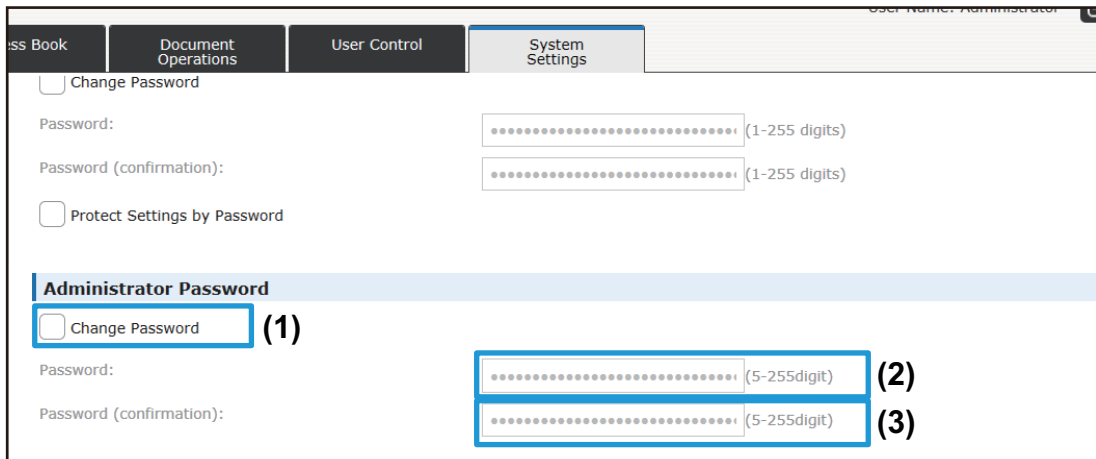

The screenshot shows the 'System Settings' tab selected. Under 'Administrator Password', the 'Change Password' checkbox is checked and circled in blue with the number (1). Below it, the 'Password' text box is circled in blue with the number (2), and the 'Password (confirmation)' text box is circled in blue with the number (3). The interface also shows other settings like 'Change Password' and 'Protect Settings by Password' at the top.



When you change the password, be sure to remember the new password.

4

When you have finished configuring settings, click the [Submit] button, click the [Logout] button, and exit the web browser.

Port Control

This section explains how to set the port used to access the machine (Server Port) and the port used to access other networks from the machine (Client Port). When an unused port is in a useable state, that port may be used for unauthorized access. By changing the port number, you can prevent access by users who do not know the port number, enabling safer use of the machine.



Port Control should only be performed by an administrator who has a thorough knowledge of the network. Indiscriminately changing a port number may make it impossible to connect to the machine.

1

Connect to the web page as explained in "[Accessing the web page](#)" ([▶ page 3](#)).

2

Display the "Port Control" setting screen.

(1) Click the [System Settings] tab ().

The setting items of the system settings appear in the setting area.

(2) Click the [Security Settings] button ().

(3) Click [Port Control].

Port control settings appear on the right side of the page.

3

Configure the Server Port and Client Port settings.

- (1) To enable/disable a port, select "Enable" or "Disable".
- (2) To change a port number, enter the new port number in the text box.

The screenshot shows the 'Port Control' section of a web interface. At the top, there are navigation tabs: 'Class Book', 'Document Operations', 'User Control', and 'System Settings'. Below these are buttons for 'Submit(U)' and 'Update(R)', and a 'Back to Me' link. The 'Server Port' section lists five protocols: HTTP, HTTPS, FTP Print, Raw Print, and LPD. Each protocol has an 'Enable' dropdown menu and a 'Port Number' text box. The dropdowns are currently set to 'Enable'. The port numbers are 80, 443, 21, 9100, and 515 respectively. A range '(0-65535)' is shown next to each port number. Blue boxes highlight the 'Enable' dropdowns (labeled (1)) and the 'Port Number' text boxes (labeled (2)).

Protocol	Enable	Port Number	Range
HTTP:	(1) Enable	80	(0-65535) (2)
HTTPS:	Enable	443	(0-65535)
FTP Print:	Enable	21	(0-65535)
Raw Print:	Enable	9100	(0-65535)
LPD:	Enable	515	(0-65535)

4

When you have finished configuring settings, click the [Submit] button, click the [Logout] button, and exit the web browser.

Category Setting

A "Category" can be set for an address. By setting a category for an address, the category can be used to filter addresses when searching for that address, making it easier to find the address.

Any name can be set for a category. By assigning distinctive names to categories, addresses can be easily sorted.

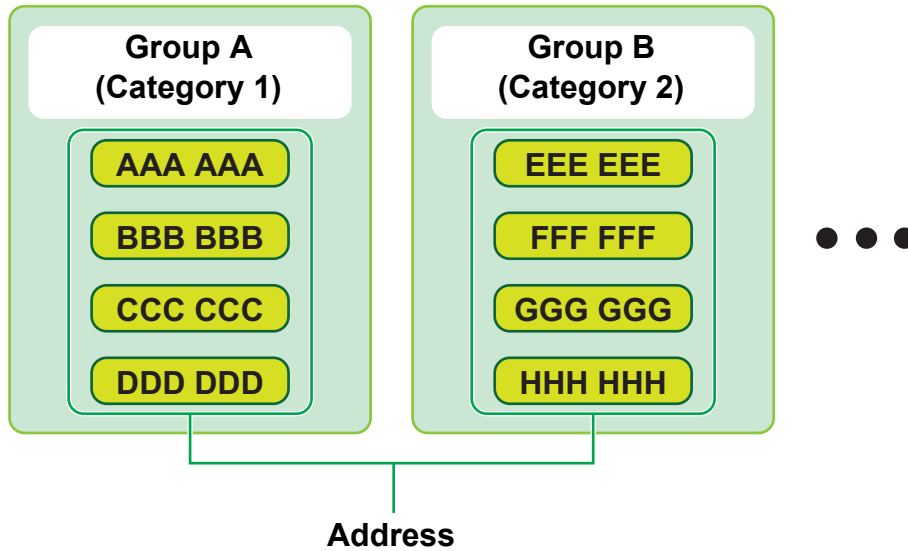

1

Connect to the web page as explained in "[Accessing the web page](#)" ([page 3](#)).

2

Display the "Category Setting" setting screen.

(1) Click the [Address Book] tab ().

The address book items appear in the setting menu.

(2) Click the [Category Setting] tab.

The Category Setting screen appears on the right side.

3

Configure the Category Setting.

Enter the new name you want to set in the "Category" text box.

4

When you have finished configuring settings, click the [Submit] button, click the [Logout] button, and exit the web browser.



When you set a category name in the category settings, register the category in "Address Registration" of the Address Book.

Address Book | Document Operations | User Control | System Settings

Address Registration

Submit(U) | Submit and Register Next(C) | Back(Q)

Type:

Search Number: (1-2000)

Address Name (Required): (Up to 36)

Initial: (Up to 10 characters)

Category:

Document Operations

The machine's Web page shows files that have been stored in Document Filing in list format. You can also show the files in thumbnail format. When thumbnail format is used, a thumbnail of each file appears, allowing you to visually check the file. The procedure for changing the display format from list to thumbnails is explained below.

File Name	User Name	Job Classification	Color Information	Form
<input type="checkbox"/> HDD_20150731_165638	User Unknown	Scan to HDD	Auto	Comp
<input type="checkbox"/> HDD_20150731_144354	User Unknown	Scan to HDD	Auto	---
<input type="checkbox"/> HDD_20150731_143915	User Unknown	Scan to HDD	Auto	DOC
<input type="checkbox"/> HDD_20150731_143901	User Unknown	Scan to HDD	Auto	---
<input type="checkbox"/> HDD_20150730_210535	User Unknown	Scan to HDD	Auto	---
<input type="checkbox"/> Book1	S123232	Printer	Auto	---
<input type="checkbox"/> No title	S123232	Printer	Auto	---
<input type="checkbox"/> No title	S123232	Printer	Auto	---
<input type="checkbox"/> No title	S123232	Printer	Auto	---

List



Thumbnail

1

Connect to the web page as explained in "[Accessing the web page](#)" ([page 3](#)).

2

Display the settings screen of "Select File" of "Document Operations".

(1) Click the [Document Operations] tab ().

The Document Operations items appear in the setting menu.

(2) Click the folder ([Main Folder], [Quick File Folder], or [Custom Folder]) you want to set in.

The file selection screen appears on the right side.

3

Change "Display Style" to "Thumbnail".

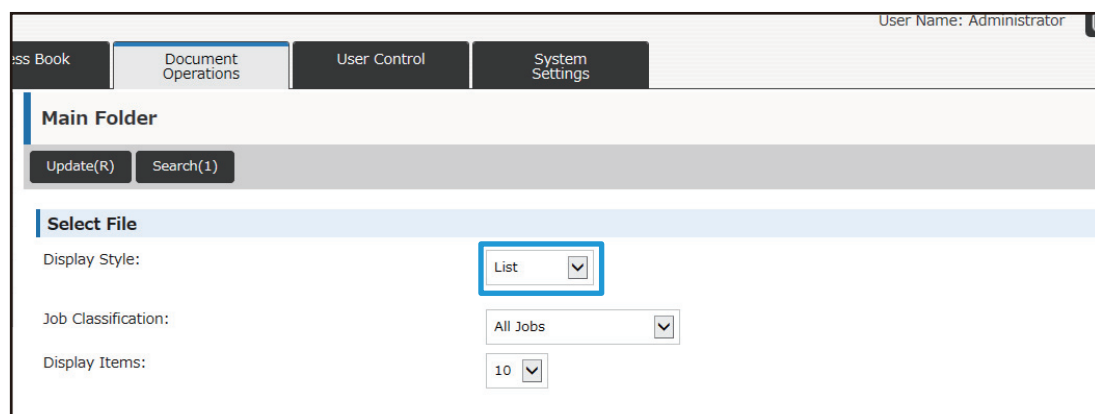

Files saved by Document Filing are shown as thumbnails.





User Control

User Control allows you to register and manage the users who use the machine.

By limiting the number of pages and functions that a user or a group of users can use, incorrect use of the machine can be prevented.

To prevent unauthorized use, persons who are not registered can be prohibited from using the machine or prohibited from using certain functions.

Example: Information stored in User Name Registration

	User Name : AAA Custom Index : Group A Pages Limit Group : "Limited" group	Authority Group: User Favorite Operation Group: Group a
	User Name : BBB Custom Index : Group B Pages Limit Group : "Limited" group	Authority Group: User Favorite Operation Group: Group a
	User Name : CCC Custom Index : Group A Pages Limit Group : "Unlimited" group	Authority Group: Administrator Favorite Operation Group: Group b
	User Name : None (Users not registered in the machine)	

Custom Index



Using the machine

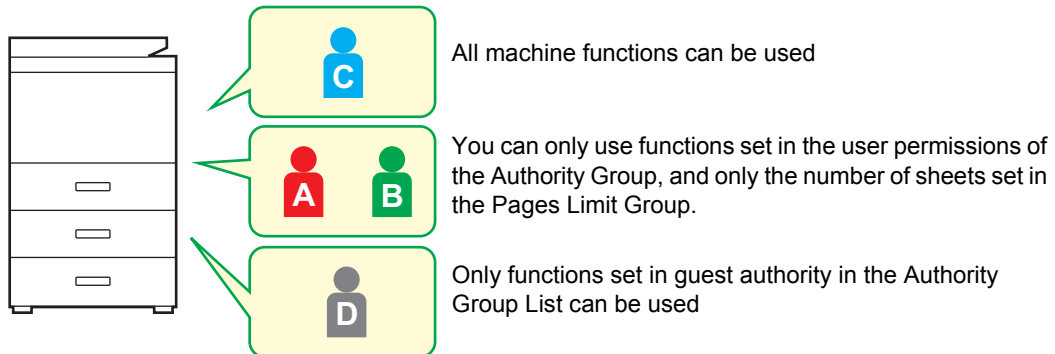

Favorite Operation Group



The machine can be operated using the screen displays and default settings set for each group.

Custom Index

When a user is registered, an index is set. You can set any name for a custom index, and by assigning distinctive names, you can easily find users.

How to filter custom indexes

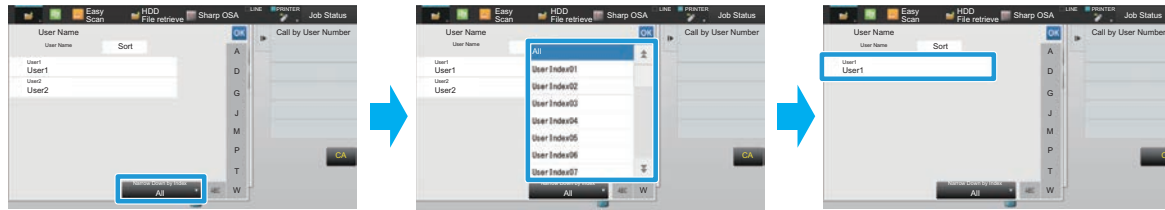

1

Connect to the web page as explained in "[Accessing the web page](#)" ([page 3](#)).

2

Display the "Custom Index" setting screen.

(1) Click the [User Control] tab. ()

The User Control items appear in the setting menu.

(2) Click [Custom Index].

The Custom Index items appear in the frame.

3

Configure the Custom Index.

Enter the new name you want to set in the "Custom Index" text box.

No.	Index
1	<input type="text" value="User 1"/>
2	<input type="text" value="User 2"/>
3	<input type="text" value="User 3"/>
4	<input type="text" value="User 4"/>

4

When you have finished configuring settings, click the [Submit] button, click the [Logout] button, and exit the web browser.

Organization /Group List

A user can be registered in an organization/group to enable sharing the contacts and group information registered in that group. When counting all used pages, you can check how many pages and what functions are used by each group. Multiple organizations/groups can be set for a user.

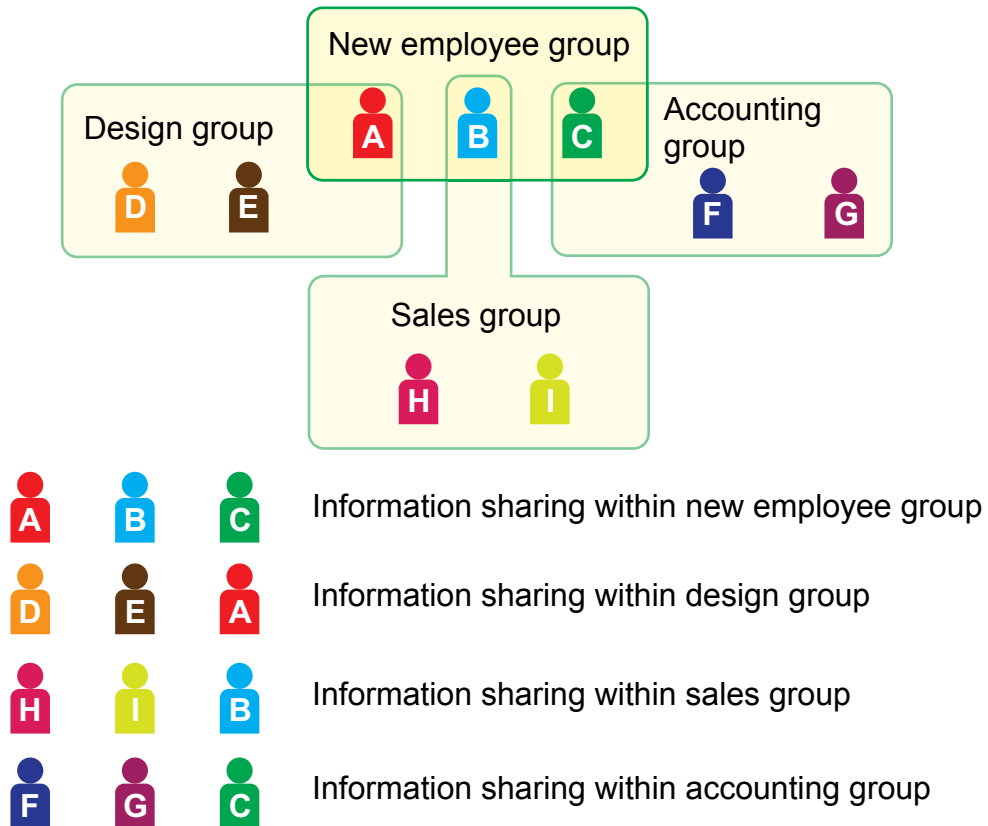

1

Connect to the web page as explained in "[Accessing the web page](#)" ([▶ page 3](#)).

2

Display the "Organization /Group List" setting screen.

(1) Click the [User Control] tab. ()

The User Control items appear in the setting menu.

(2) Click [Organization /Group List].

The Custom Index items appear on the right side.

3

Configure the Organization /Group List settings.

Enter the new name you want to set in the "Organization /Group List" text box.

User Name: Administrator

Class Book | Document Operations | **User Control** | System Settings

Organization /Group List

Enter group name.(Up to 255 characters)

No.	Organization/Group
1	<input type="text" value="Group1"/>
2	<input type="text" value="Group2"/>
3	<input type="text" value="Group3"/>
4	<input type="text" value="Group4"/>

4

When you have finished configuring settings, click the [Submit] button, click the [Logout] button, and exit the web browser.

Page Limit Group List

A Page Limit Group List can be used to limit the number of sheets that users in a specific group can use for copies or print jobs, and limit the number of pages that can be scanned or faxed. The users can also be prohibited from using certain functions.



Color copy and color print settings only appear on a full-color machine.

Page Limit Group List A
Copy :
B/W : Page Limit (10000)
Full Color : Page Limit (10000)
Printer :
B/W : Unlimited
Full Color : Prohibited
Document Filing Print :
B/W : Unlimited
Full Color : Unlimited
List Prints :
B/W : Unlimited
Full Color : Unlimited
Scanner :
B/W : Prohibited
Full Color : Prohibited
Fax Send : Prohibited
Scan to HDD :
B/W : Page Limit (50000)
Full Color : Page Limit (50000)

This section explains how to set the Page Limit Group List.

- Users in this group can use up to 10,000 pages for each color and black & white copying.
- There is no limit on black & white printing.
- Color printing cannot be used.
- Both color and black & white Document Filing Print and List Print can be used without restriction. Scanner and fax transmission cannot be used.
- Up to 50,000 pages each can be used for color and black & white scan save.

1

Connect to the web page as explained in "[Accessing the web page](#)" ([▶ page 3](#)).

2

Display the "Pages Limit Group" setting screen.

(1) Click the [User Control] tab. ()

The User Control items appear in the setting menu.

(2) Click [Pages Limit Group].

The Pages Limit Group items appear on the right side.

3

Configure the Pages Limit Group settings.

(1) Click the [Add] button.

To edit an existing group, select the group you want to edit.

The screenshot shows a web interface with a navigation bar at the top containing 'ISS Book', 'Document Operations', 'User Control', and 'System Settings'. Below the navigation bar, the 'Default Group List' section is visible. It includes a 'Group Name' field with the value 'Unlimited'. Below this is a table with two columns: 'No.' and 'Group Name'. The first row in the table has 'Not Set' in the 'No.' column and an empty 'Group Name' cell. Below the table are two buttons: 'Select All(S)' and 'Clear Checked(K)'. At the bottom of the table area, there are two buttons: 'Add(Y)' and 'Return to the Defaults(C)'. The 'Add(Y)' button is highlighted with a blue box. At the very bottom of the page, there is an 'Update(R)' button and a 'Top of Page' link.

(2) Configure the Pages Limit Group settings.

- Enter a new group name in the "Group Name" text box.
- If other page limit groups are already set, you can select a group with settings close to the desired settings and use "Select the Group Name to be the Registration Model" to apply the settings of the selected group to the new group.
- Select "Unlimited", "Prohibited" or "Limited" from the menu.
"Unlimited" allows an unlimited number of pages to be used. "Prohibited" prohibits the use of that function. If you selected "Limited", enter the page limit.

The screenshot shows a web interface with a navigation bar at the top containing 'ISS Book', 'Document Operations', 'User Control', and 'System Settings'. The 'User Control' tab is active. The 'Pages Limit Group Registration' form is displayed. It includes a 'Submit(U)' button and a 'Cancel(C)' button. Below these buttons are three main sections: 'Group Name:' with a text input field (up to 32 characters), 'Select the Group Name to be the Registration Model' with a dropdown menu set to 'Unlimited', and 'Copier:' with two rows. The first row is for 'Black & White' and the second is for 'Full Color'. Each row has a dropdown menu set to 'Unlimited' and a 'Page Limit' text input field (1-99,999,999). The 'Group Name' field, the 'Select the Group Name to be the Registration Model' dropdown, and the 'Page Limit' fields are highlighted with a blue box. The top right corner of the page shows 'User Name: Administrator'.

4

When you have finished configuring settings, click the [Submit] button, click the [Logout] button, and exit the web browser.

Authority Group List

Authority Group List is used to restrict the functions and settings that users who belong to a specific group can use. By setting restrictions on functions and settings, you can prevent inexperienced users from performing incorrect operations and settings, and thereby enable safe use of the machine.



Color copy and color print settings only appear on a full-color machine.

Main authority types (Default Group List)

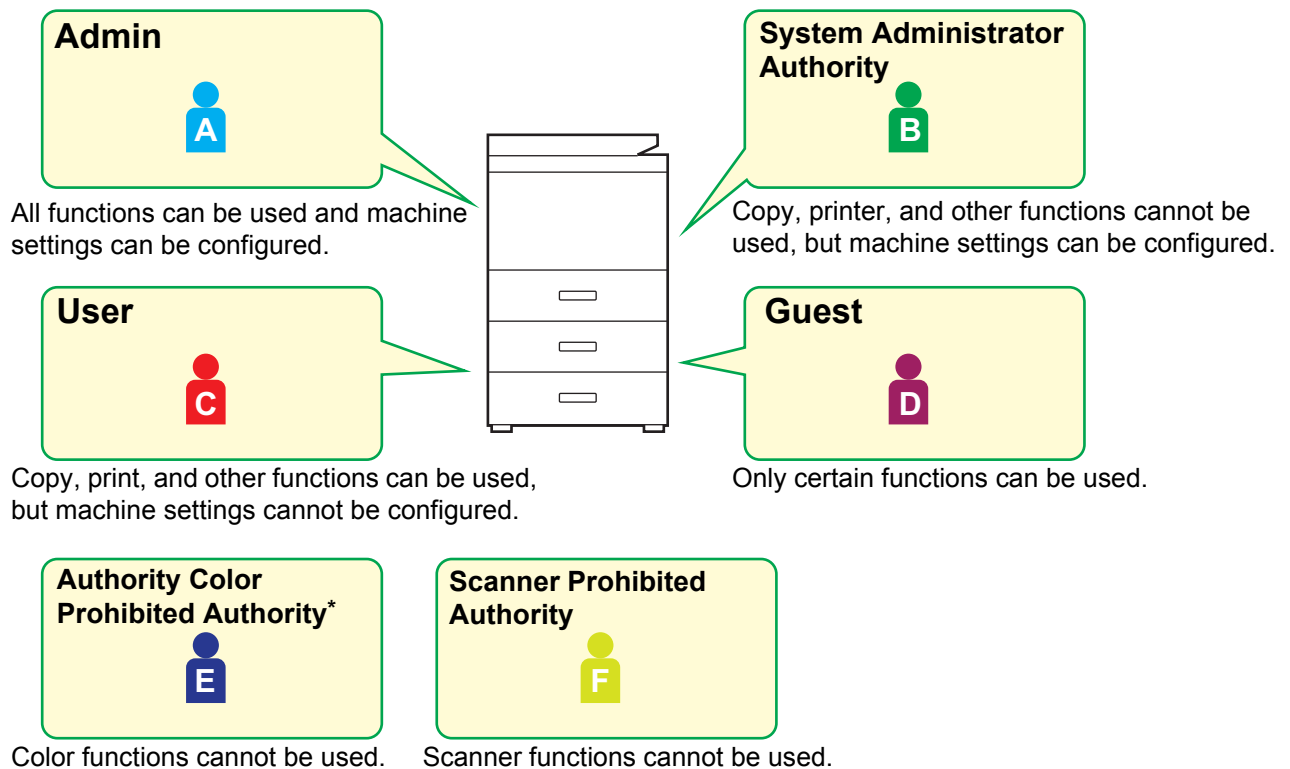

* This can be set on a full-color machine.

1

Connect to the web page as explained in "[Accessing the web page](#)" ([page 3](#)).

2

Display the "Authority Group" setting screen.

(1) Click the [User Control] tab. ()

The User Control items appear in the setting menu.

(2) Click [Authority Group].

The Authority Group items appear on the right side.

3

Configure the Authority Group settings.

(1) Click the [Add] button.

To edit an existing group, select the group you want to edit.

The screenshot shows a web interface with a navigation bar at the top containing 'Job Book', 'Document Operations', 'User Control', and 'System Settings'. Below the navigation bar is a 'Group List' section. It features a table with two columns: 'No.' and 'Group Name'. The first row shows 'Not Set' and 'a'. Below the table are buttons for 'Select All(S)', 'Clear Checked(K)', and 'Add(Y)'. At the bottom, there is a 'Return to the Defaults:' section with a dropdown menu labeled 'Please select Authority.' and an 'Execute(J)' button. A footer bar contains 'Update(R)' and 'Top of Page'.

(2) Configure the Authority Group settings.

- Enter the name of the authority group in "Group Name".
- You can select a group with settings close to the desired settings from the default group list and use "Select the Group Name to be the Registration Model" to apply the settings of the selected group to the new group.
- The [Job Settings] tab is used to specify whether or not copy, printer, fax / image send, and other functions are allowed.
- The [Machine Settings] tab is used to specify whether or not machine settings are allowed.

The screenshot shows the 'Authority Group Registration' configuration page. It has a navigation bar with 'Job Book', 'Document Operations', 'User Control', and 'System Settings'. Below the navigation bar are 'Submit(U)' and 'Cancel(C)' buttons. The main content area includes a 'Group Name:' text input field (with a note '(Up to 32 characters)'), a 'Select the Group Name to be the Registration Model:' dropdown menu (currently showing 'User'), and a 'Switch to Single Screen' link. Below this are two tabs: 'Job Settings' (selected) and 'Machine Settings'. Under the 'Job Settings' tab, there is a 'Copy' section with 'Color Mode Approval Setting:' options for 'Black & White' and 'Full Color', both set to 'Allowed'. A 'Top of Page' link is visible in the bottom right corner.

4

When you have finished configuring settings, click the [Submit] button, click the [Logout] button, and exit the web browser.

Favorite Operation Group List

For each group, you can register an environment with settings that are convenient for the group. For example, if the users speak different languages, a language can be set for each group, and this setting is applied automatically at login (normally the display language cannot be changed each time the machine is used).



Color copy and color print settings only appear on a full-color machine.

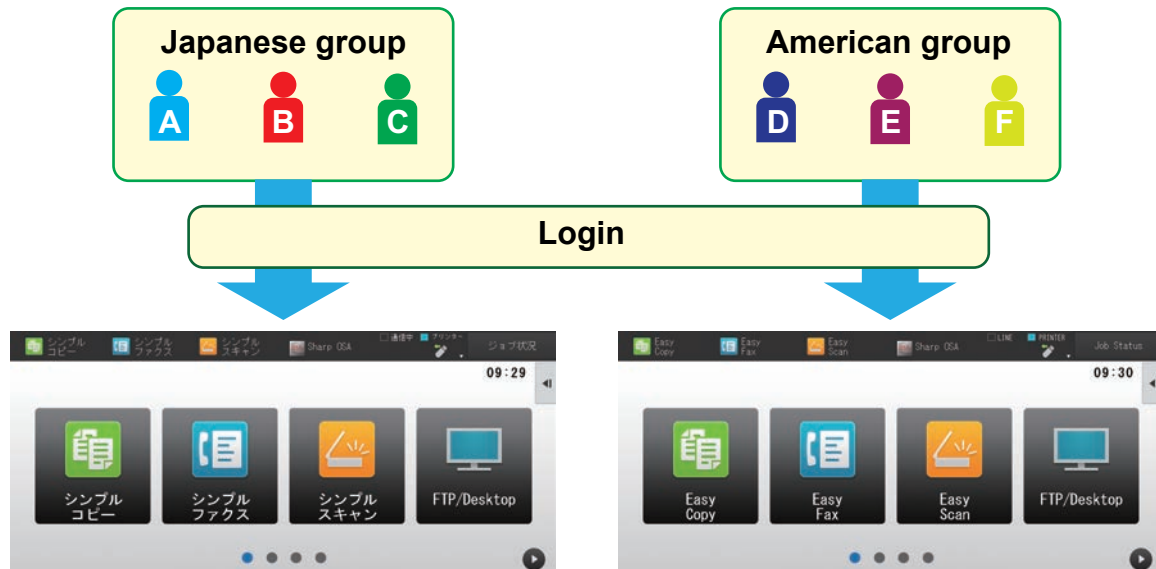

By setting English for an American group and Japanese for a Japanese group in the Favorite Operation Group List, the language will automatically switch between English and Japanese when a user logs in to the machine.

1

Connect to the web page as explained in "[Accessing the web page](#)" ([page 3](#)).

2

Display the "Favorite Operation Group List" setting screen.

(1) Click the [User Control] tab. ()

The User Control items appear in the setting menu.

(2) Click [Favorite Operation Group List] in [Favorite Operation Group].

The Favorite Operation Group List items appear on the right side.

3

Configure the Favorite Operation Group List settings.

(1) Click the [Add] button.

To edit an existing group, select the group you want to edit.

No.	Group Name
Not Set	

(2) Configure the Favorite Operation Group List.

- Enter a name for the Favorite Operation Group List in "Group Name".
- If there are other registered Favorite Operation Group Lists, you can select the group with the settings that are close to the desired settings and use "Select the Group Name to be the Registration Model" to apply the settings of the selected group to the new group.
- Click the "Copy", "Image Send", "Document Filing", and "System Settings" tabs, and set the functions and settings that you want to store in the group.

Copy	Image Send	Document Filing	System Settings
------	------------	-----------------	-----------------

4

When you have finished configuring settings, click the [Submit] button, click the [Logout] button, and exit the web browser.

System Settings

The system settings are used to configure machine settings. Home screen settings and mode key settings are explained in the following.

Home Screen Settings

The shortcut keys in the home screen can be changed to suit your needs. It is convenient to register frequently used functions in shortcuts.

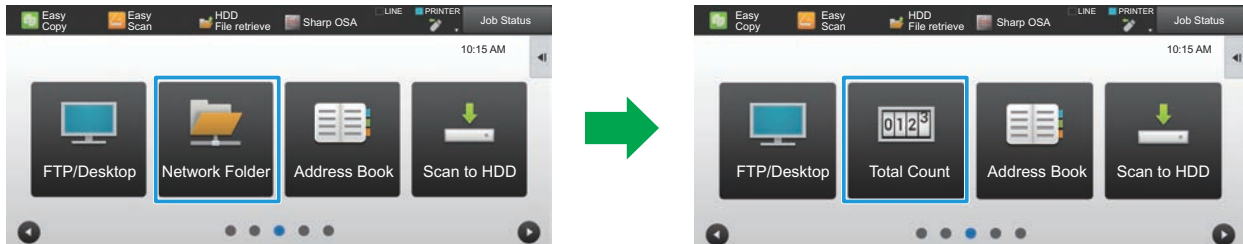

Changing a shortcut from "Network Folder" to "Total Count" in the home screen settings

1 Connect to the web page as explained in "[Accessing the web page](#)" ([page 3](#)).

2 Display the "Home Screen Settings" setting screen.

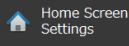
- (1) Click the [System Settings] tab ().
The setting items of the system settings appear in the setting area.
- (2) Click the [Home Screen Settings] button ().
- (3) Click [Condition Settings].
The Condition Settings items appear on the right side.

3 Click the function name of the number of the shortcut key that you want to change.

No.	Home Button
1	CLOUD PORTAL
2	Easy Copy
3	Easy Scan
4	Easy Fax
5	Sharp OSA
6	Copy
7	E-mail
8	Fax
9	FTP/Desktop
10	Network Folder

Previous(M) 1 / 6 Next(N) ^ Top of P

4

Set the short cut on home screen.

Select the item that you want to set.

The screenshot shows a web interface with a navigation menu at the top containing 'ISS Book', 'Document Operations', 'User Control', and 'System Settings'. The main content area is titled 'Home Screen Registration' and includes 'Submit(U)' and 'Cancel(C)' buttons. Below this, a section titled 'Home ButtonNo.2:Easy Copy' is highlighted. It contains a 'Copy:' label and a list of radio button options: 'None', 'Easy Copy' (which is selected and highlighted with a blue box), 'Copier', 'Program List', 'Program', 'Print Release', and 'Made You'. To the right of the list is a 'Pre-Setting Program' dropdown menu. At the bottom right, there is a 'Top of P' button.

5

When you have finished configuring settings, click the [Submit] button, click the [Logout] button, and exit the web browser.

Key Layout of the Screen

The number of shortcuts in the home screen can be changed.

1

Display the setting screen of step 3 as explained in "[Home Screen Settings](#)" ([▶ page 27](#)).

2

Select the desired layout pattern from "Template".

The "Key Layout of the Screen" illustration varies depending on which pattern is selected. Refer to the illustrations to select the pattern you want to set.

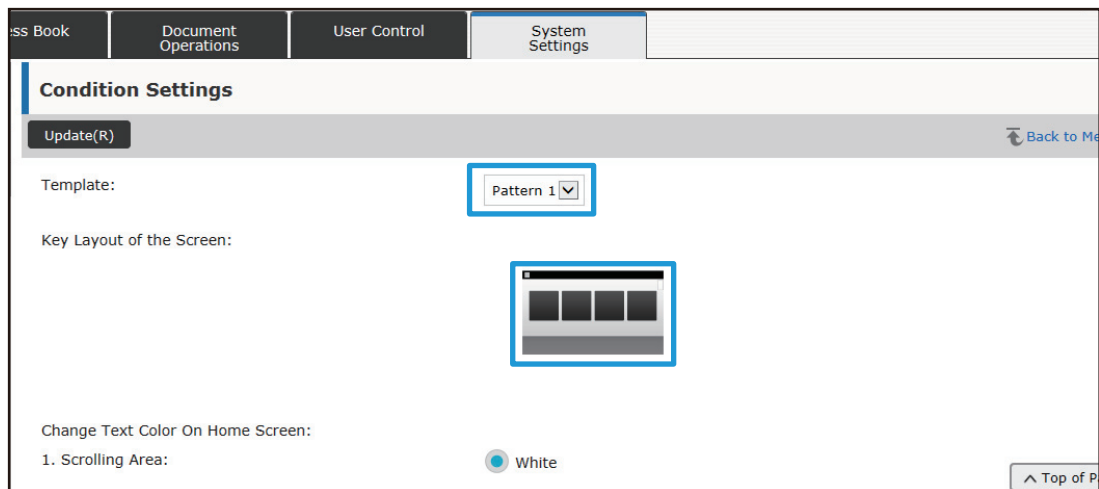

3

When you have finished configuring settings, click the [Submit] button, click the [Logout] button, and exit the web browser.



If you changed the layout, the "Settings" may not appear, depending on the settings. If you want to change machine settings when the "Settings" key does not appear, change the settings on the Web page, or use "Edit Home" on the machine's operation panel to add the "Settings" key.

Mode Key Display Setting

The mode keys are function shortcut keys that appear at the top of the screen. This section explains the display settings for the mode keys.

1 Connect to the web page as explained in "[Accessing the web page](#)" ([▶ page 3](#)).

2 Display the "Common Settings" setting screen.

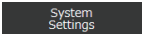
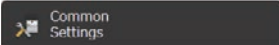
- (1) Click the [System Settings] tab ().
The setting items of the system settings appear in the setting area.
- (2) Click the [Common Settings] button ().
- (3) Click [Mode Key Display Setting] in [Operation Settings].
The mode key display settings are shown on the right side.

3 Configure the Mode Key Display Setting.

Modes to Display

Select the modes to be displayed with the mode keys. Select the checkboxes of the modes you want to display.

Display Mode Keys on Home

If you want to display a mode key in the home screen, select the checkbox of that key.

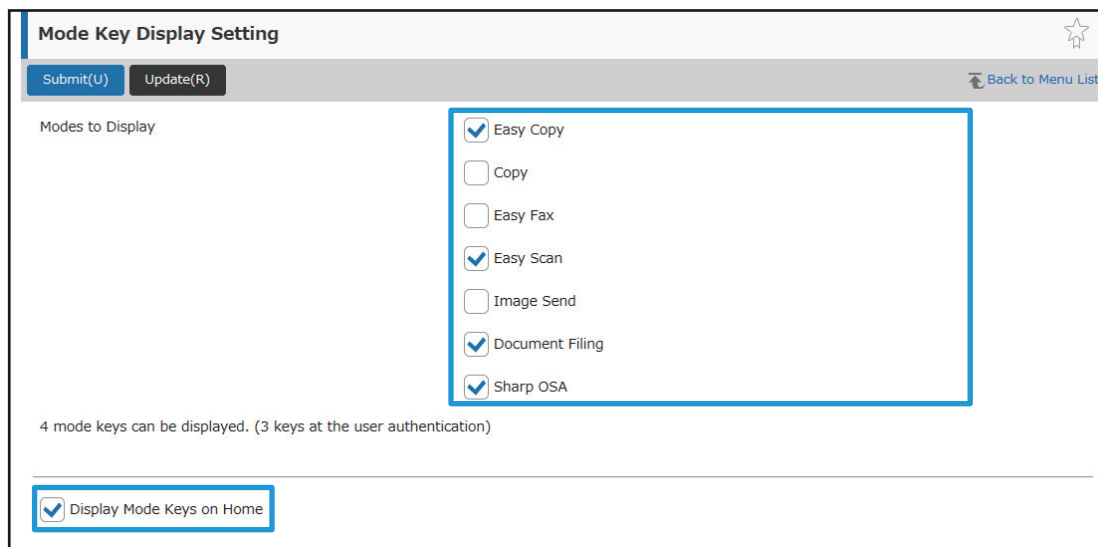

4 When you have finished configuring settings, click the [Submit] button, click the [Logout] button, and exit the web browser.

CUSTOMIZING THE WEB PAGE

To make the web page easier to use, you can permanently display web addresses registered in the web page setting menu and add frequently used settings to the Shortcut tab for easy access.

Custom Link Setting

You can display registered web addresses in the display field of the setting menu. By clicking on a custom link, you can jump to the web site of the registered address.

1

Connect to the web page as explained in "[Accessing the web page](#)" ([▶ page 3](#)).

2

Display the "Custom Links" setting screen.

(1) Click the [System Settings] tab ().

The setting items of the system settings appear in the setting area.

(2) Click the [Common Settings] button ().

(3) Click [Custom Links].

Custom link settings appear on the right side.

3

Set the custom link.

(1) To add a new link, click the [Add] button. To edit an existing custom link, click the link name.

(2) Enter the link name and the web address.



To delete a custom link, select the checkbox of the custom link and click the [Delete] button. A confirmation window appears. Click the [OK] button.

4

When you have finished configuring settings, click the [Submit] button, click the [Logout] button, and exit the web browser.

Shortcuts

You can click the shortcut icon (★) at the top right of the web page setting area to create a new tab in the menu tabs and add the currently displayed setting item.

1

Connect to the web page as explained in "[Accessing the web page](#)" ([page 3](#)).

2

Display the setting screen you want to register.

3

Click the shortcut icon (★) at the top right of the setting area.

A shortcut tab is added to the menu tabs and the displayed setting is registered on the shortcut tab.

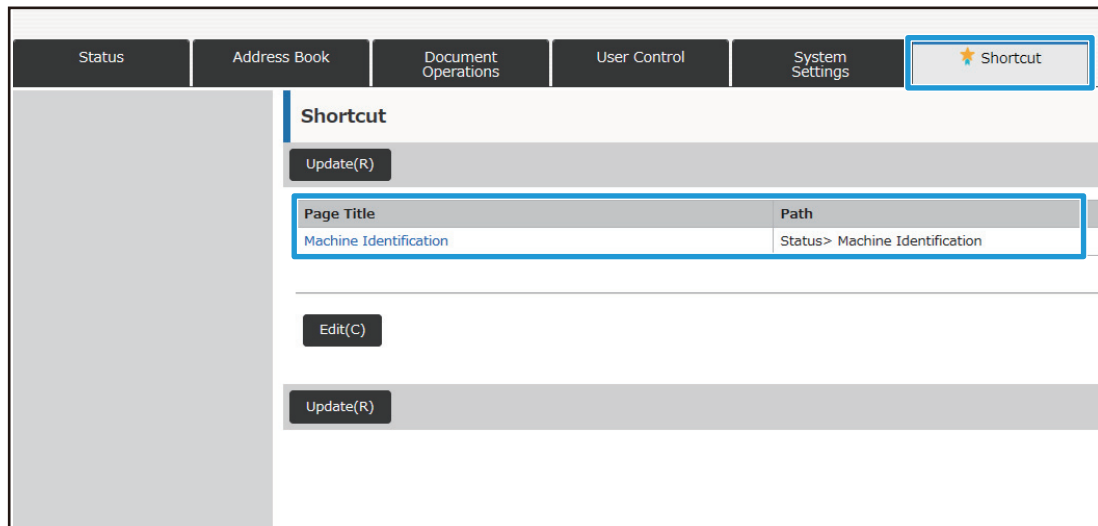

- To delete a shortcut, click the [Edit] button. Select the checkbox of the item you want to delete in the items that appear and click the [Delete] button. A confirmation window appears. Click the [OK] button.
- The shortcut icon of the setting registered in the shortcut changes to ★.

4

When you have finished configuring settings, click the [Submit] button, click the [Logout] button, and exit the web browser.

WEB PAGE SETTING LIST

For the detailed explanations of each item, see the User's Manual.

Tab item	Setting item		
Status	Machine Identification		
	Total Count		
	Device Status		
	Network Status		
	Firmware Version		
	Power Reset		
	Data List	List for User	
	List for Administrator		
Address Book	Address Book		
	Category Setting		
Document Operations	Document Filing	Main Folder	
		Quick File Folder	
		Custom Folder	
		My Folder	
		Search	
	File Batch Print		
	Submit Print Job		
User Control	User Control	User List	
		Custom Index	
		Organization /Group List	
	Default Settings		
	Pages Limit Group		
	Machine Page Limit Setting		
	Authority Group		
	Favorite Operation Group	Favorite Operation Group List	
		Favorite Key List	
		Home Screen List	
	User Count	View User Count	
		Save User Count	
	Billing Code Setting	Administration Settings	
		Main Code List	
Sub Code List			

Web Page Settings Guide

Tab item	Setting item		
User Control	Card Setting	Card Area Setting	
		Card Type / Card Reader Settings	
System Settings	Home Screen Settings	Condition Settings	
		Icon	
		Background Image	
	Copy Settings	Condition Settings	
		Initial Status Settings	
		Text /Image Printing	Text Settings (Stamp)
			Custom Stamp
	Custom Watermark		
	Printer Settings	Condition Settings	
		Initial Status Settings	
		PCL Settings	
		PostScript Settings	
		OOXML Settings	
		Print Release Settings	
		E-mail Print Settings	
		Direct Print Settings (FTP)	
		Direct Print Settings (Network Folder)	
		Print Setting from PC/Mobile Terminal	
	Image Send Settings	Common Settings	Condition Settings
			Enable/Disable Settings
			Own Number and Name Set
		Scan Settings	Initial Status Settings
			Condition Settings
			Default Address
			Administration Settings
			Subject Name Settings
File Name Settings			
Message Body Settings			

Web Page Settings Guide

Tab item	Setting item			
System Settings	Image Send Settings	Fax Settings	Default Settings	
			Send Settings	
			Receive Settings	
			Polling Setting	
			F-Code Memory Box	
		Internet Fax Settings	Default Settings	
			Send Settings	
			Receive Settings	
			Server Settings	
		Fax Data Receive/Forward (Manual)		
		Inbound Routing (Forwarding/Storing) Settings	Inbound Routing Settings	
			Sender Address Registration	
			Administration Settings	
			Inbound Routing (Storage) Settings	
		Metadata Settings		
	Document Filing Settings	Condition Settings		
		Automatic Deletion of File Settings		
	Sharp OSA Settings	Standard Application Settings		
		Receiving Application Setting		
		External Accounting Application Settings		
		Embedded Application Settings		
		Polling Setting		
	Common Settings	Paper Settings	Paper Tray Settings	
			Custom Size Registration (Bypass)	
			Paper Type Registration	
		Operation Settings	Condition Settings	
			Easy Mode Settings	
			Favorite Key Setting	
			Mode Key Display Setting	
		Keyboard Settings	Default Keyboard Setting	
Soft Keyboard Template Setting				
Device Control				

Web Page Settings Guide

Tab item	Setting item		
System Settings	Common Settings	Enable/Disable Settings	
		Machine Identification Settings	
		Clock Adjust	
		Product Key	
		Custom Links	
	Network Settings	Quick Settings	
		Network Name Setting	
		Protocol Settings	
		Services Settings	
		Print Port Settings	
		External Print Services Settings	Google Cloud Print Settings
		External Service Connect	AirPrint Settings
			Cloud Connect Settings
			E-mail Connect Settings
		LDAP Settings	
		Active Directory Settings	
		Public Folder / NAS Setting	
		Proxy Setting	
		Wireless Settings	
		Device Web Page Setting	
	Security Settings	Password Change	
		Port Control	
		Filter Setting	
		SSL Settings	Condition Settings
		S/MIME Settings	Make of Certificate Signing Request(CSR)
		IPsec Settings	Condition Settings
		IEEE802.1X Setting	Make of Certificate Signing Request(CSR)
		Security Control	
		Document Administration Function	

Web Page Settings Guide

Tab item	Setting item		
System Settings	Security Settings	Hidden Pattern Print Setting	Initial Status Settings
			Contrast
			Custom Text Registration
	Energy Save	Tracking Information Print	
		Eco Setting	
		Eco Scan Setting	
		Energy Saving Pattern List	
		Specific Date Operation Settings	
		Power ON/OFF Schedule Setting	
	System Control	Toner Save Mode	
		Job Log	Job Log Operation
			View Job Log
		Data Import/Export (CSV Format)	
		Storage Backup	
		Device Cloning	
		Filing Data Backup	
		Storing/Calling of System Settings	
		Reset Settings	
		E-mail Alert and Status	Status Message
	Alerts Message		
	Image Quality Adjustment	Collective Adjustment	
		Copy Image Quality	
		Print Image Quality	
		Scan Image Quality	
		Color Profile Settings*	
	Initial Installation Settings	Condition Settings	
		Network Quick Settings	
		Paper Tray Settings	
Product Key			

* This can be set on a full-color machine.

SHARP[®]
SHARP CORPORATION